

Panasonic[®]

Owner's Manual for advanced features

Digital Camera

Model No. **DMC-F5**

LUMIX

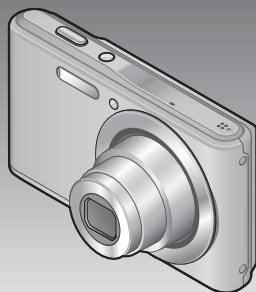

Please read these instructions carefully before using this product, and save this manual for future use.



Register online at
www.panasonic.com/register
(U.S. customers only)

VQT4W38
M1212KZ0

Contents

Before use

Before use	5
Standard Accessories	7
Names and Functions of Main Parts	8
Cursor button	10

Preparations

Charging battery	11
Inserting the battery	12
Charging the battery	13
Remaining battery	15
Guidelines for number of recordable pictures and operating time	15
Inserting and removing the card (optional)	16
About built-in memory/cards	17
Saving your pictures (cards and built-in memory)	17
Recording capacity guidelines (pictures/recording time)	18
Setting the clock	19
Changing time setting	20

Basics

Sequence of operations	21
Taking pictures with automatic settings [Auto Scene Mode]	24
Using flash	25
Automatic Scene Detection	25
[Auto Scene Mode] restrictions	26
Taking pictures with your own settings [Normal Picture] Mode	27
Adjusting focus	28
Recording motion pictures	29
Viewing your pictures [Normal Play]	31
Zooming in and viewing "Playback Zoom"	32
Viewing a list of pictures "Multi Playback"	32
Searching pictures by their recording date "Calendar"	33
Viewing motion pictures	34
Deleting pictures	35
To delete multiple (up to 50)/To delete all pictures	36
Setting the menu	37
Menu type	38

Using the [Setup] menu	39
[Clock Set]	39
[Beep]	39
[Volume]	39
[Video Rec Area]	39
[Auto Power Off]	39
[Light Freq.]	40
[Auto Review]	40
[Reset]	40
[Version Disp.]	40
[Format]	41
[Language]	41
Application (Record)	
Changing recording information display	42
Using Zoom	43
Zoom types and use	44
Taking pictures with flash	45
Taking pictures with self-timer	47
Taking pictures with Exposure Compensation	48
Taking panorama pictures [Panorama Shot] Mode	49
Taking pictures according to the scene [Scene Mode]	52
[Portrait]	53
[Scenery]	53
[Sports]	53
[Night Portrait]	54
[Night Scenery]	54
[Food]	54
[Baby]	55
[Sunset]	55
[High Sens.]	55
Using the [Rec] menu	56
[Picture Size]	56
[Sensitivity]	57
[White Balance]	58
[AF Mode]	59
[Digital Zoom]	60
[Burst]	60
[Color Mode]	61
[Red-Eye Removal]	61
[Date Stamp]	62
[Clock Set]	62
Using the [Motion Picture] menu	63
[Rec Quality]	63

Application (View)

Different playback methods [Playback Mode]	64
[Slide Show].....	65
[Category Selection].....	66
[Calendar].....	66
Using the [Playback] menu	67
[Resize].....	67
[Protect].....	69
[Copy].....	70

Connecting with other devices

Using with your PC	71
Using the supplied software.....	72
Installing supplied software (PHOTOfunSTUDIO).....	73
Copying still pictures and motion pictures.....	74
Printing	76
Printing multiple pictures.....	77
Making print settings on the camera.....	78
Printing with date and text.....	79

Others

List of LCD monitor displays	80
Message displays	82
Q&A Troubleshooting	84
Usage cautions and notes	90

■ How to read this document

- Recording mode icons

Recording mode: 

Available recording modes

Unavailable recording modes

Before use

■ Camera handling



Keep the camera away from excessive vibration, force, or pressure.

- Avoid using the camera under the following conditions, which may damage the lens, LCD monitor, or camera body. This may also cause the camera to malfunction or prevent recording.
 - Dropping or hitting the camera against a hard surface
 - Sitting down with the camera in your pants pocket or forcing it into a full bag
 - Adding accessories to the camera strap
 - Pushing with excessive force on the lens or LCD monitor

The camera is not dust resistant, splash resistant, or waterproof.

Avoid using the camera in places with excessive dust or sand, or where water can come into contact with the camera.

- Avoid using the camera under the following conditions, which present a risk that sand, water, or foreign material may enter the camera through the lens or openings around buttons. Be especially careful, because these conditions may damage the camera and such damage may not be repairable.
 - In extremely dusty or sandy places
 - In the rain or by the shore, where the camera may be exposed to water

■ Condensation (When the lens or the LCD monitor is fogged up)

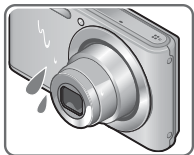

- Condensation may occur when the camera is exposed to sudden changes of temperature or humidity. Avoid these conditions, which may make the lens or LCD monitor dirty, cause mold, or damage the camera.
- If condensation does occur, turn off the camera and wait about two hours before using it. Once the camera adjusts to the surrounding temperature, the fogging will clear naturally.

■ **Always take a test shot first**

Before important events when you will use the camera (at weddings, for example), always take a test shot to make sure that pictures and sound record correctly.

■ **No compensation for missed shots**

We cannot compensate for missed shots if technical problems with the camera or card prevent recording.

■ **Carefully observe copyright laws**

Unauthorized use of recordings that contain works with copyright for purposes other than personal use is prohibited under copyright law. Recording of certain material may be restricted even for the purpose of personal use.

■ **Also refer to “Usage cautions and notes” (→90)**

Standard Accessories

Check that all the accessories are supplied before using the camera.

- The accessories and their shape may differ depending on the country or area where the camera was purchased.
For details on the accessories, refer to Basic Owner's Manual.
- Battery Pack is indicated as battery pack or battery in the text.
- SD Memory Card, SDHC Memory Card and SDXC Memory Card are indicated as card in the text.
- Please dispose of all packaging appropriately.
- Keep small parts in a safe place out of the reach of children.

■ Optional accessories

- **Cards are optional.** You can record or play back pictures on the built-in memory when you are not using a card.
- If any accessories are lost, customers in the USA and Puerto Rico should contact Panasonic's parts department at 1-800-833-9626 and customers in Canada should contact 1-800-99-LUMIX (1-800-995-8649) for further information about obtaining replacement parts.

Names and Functions of Main Parts

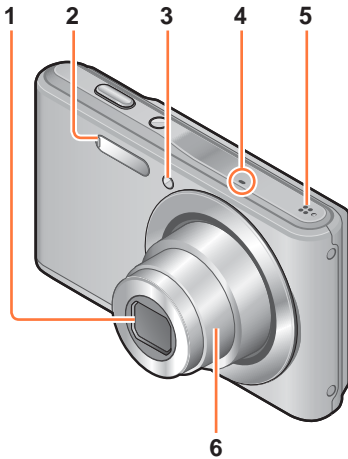

- 1 **Lens**
- 2 **Flash** (→22, 45)
- 3 **Self-timer indicator** (→47)
- 4 **Microphone** (→22, 29)
- 5 **Speaker** (→39)
- 6 **Lens barrel**

● The illustrations and screens in this manual may differ from the actual product.

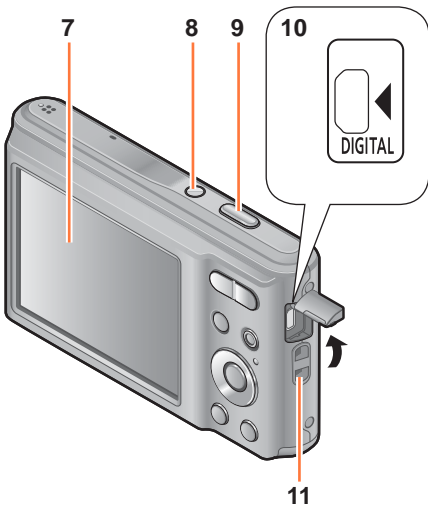

- 7 LCD monitor** (→42, 80, 81)
- 8 Camera [ON/OFF] button** (→19, 21)
Use this to turn the camera on and off.
- 9 Shutter button** (→22, 24)
Use this to focus and record still pictures.
- 10 [DIGITAL] socket** (→ 74, 76)
This socket is also used when charging the battery. (→11)
• **When connecting the USB connection cable (supplied)**
Insert the plug until the terminal part can no longer be seen. The plug will go in easier if you open the terminal cover wide.
- 11 Hand strap eyelet**
We recommend using the supplied hand strap to avoid dropping the camera.

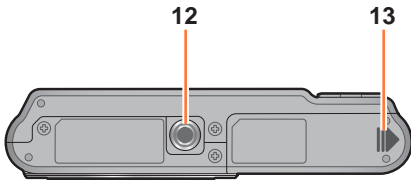
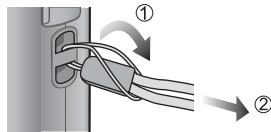

- 12 Tripod Mount** (→92)
Do not attach to a tripod with a 5.5 mm (0.22") or longer screw. Doing so may damage this unit.
- 13 Card/Battery door** (→12, 16)

● Some methods of holding the camera may block the speaker, making it difficult to hear the beep, etc.

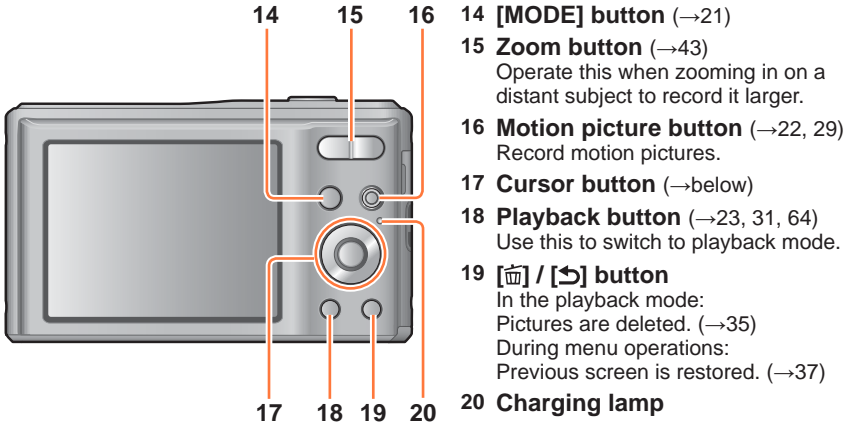

Cursor button

[MENU/SET]

Use this to display the menus, enter the settings, etc. (→37)

Left cursor button (◀)

- Self-timer (→47)

Down cursor button (▼)

- Changing information display (→42)

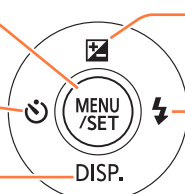

Up cursor button (▲)

- Exposure Compensation. (→48)

Right cursor button (▶)

- Flash (→45)

● In this manual, the button that is used is indicated by ▲▼◀▶.

Charging battery

Always use the dedicated AC adaptor (supplied), USB connection cable (supplied), and battery for this camera.

Always charge before first use! (battery shipped uncharged)

- Charge the battery while it is in the camera.

Camera status	Charge
Turn off	Yes
Turn on	No

- If the battery is not inserted, neither charging nor power supplying is made.

■ About batteries that you can use with this unit

It has been found that counterfeit battery packs which look very similar to the genuine products are made available to purchase in some markets. Some of these battery packs are not adequately protected with internal protection to meet the requirements of appropriate safety standards. There is a possibility that these battery packs may lead to fire or explosion. Please be advised that we are not liable for any accident or failure occurring as a result of use of a counterfeit battery pack. To ensure that safe products are used we recommend that a genuine Panasonic battery pack is used.

■ Using the camera with power supplied from an electrical outlet

When using the AC adaptor (supplied), you can use the camera while power is supplied via the USB connection cable (supplied).

The battery will need to be inserted in the camera at that time, even though it will not be charged.

- **Battery power may be consumed when taking pictures. The camera will turn off when no battery power is left.**
- Turn off the camera when connecting/disconnecting the AC adaptor.

Inserting the battery

To charge the battery, insert it into the camera.

1 Turn off the camera and slide the card/battery door out (①) before opening the door (②) as illustrated

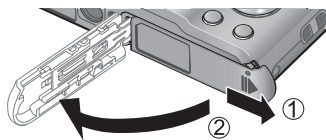

2 Insert the battery all the way

- Make sure to insert the battery in the correct orientation.
- Insert all the way firmly until a locking sound is heard, and check that the lever is hooked over the battery.



3 Close the card/battery door and slide the door in until you hear a locking sound

■ To remove battery

Move the lever in the card/battery compartment in the direction of the arrow.

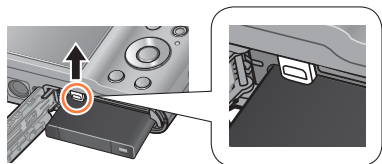

- Always use genuine Panasonic batteries.
- If you use other batteries, we cannot guarantee the quality of this product.
- **Remove battery from camera after use.**
 - Keep the battery in a plastic bag, making sure that it is kept away from metallic objects (such as clips) when carrying or storing the battery.
- To remove the battery, turn the camera off and wait until the LUMIX indicator on the LCD monitor goes off. (Failure to wait may cause the camera to malfunction and may damage the card or recorded data.)
- The unusable battery should be discarded in accordance with battery recycling laws. Call the RBRC hotline at 1-800-822-8837 for information.

Charging the battery

We recommend charging in a location where the ambient temperature is between 10 °C and 30 °C (50 °F to 86 °F) (same for the battery temperature).

Turn off the camera

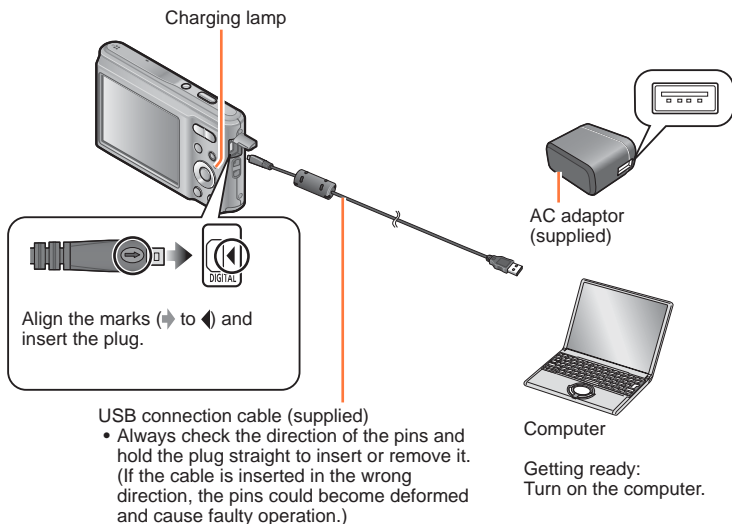

■ Charging the battery by connecting the camera to the electrical outlet

Connect the AC adaptor (supplied) and the camera using the USB connection cable (supplied), and plug the AC adaptor (supplied) into the electrical outlet.

- Be sure to only use the AC adaptor (supplied) indoors.

■ Charging the battery through the computer

Connect a computer to the camera using the USB connection cable (supplied).

- It may not be possible to charge the battery from some computers depending on the computer specifications.
- If the computer enters sleep mode during charging, charging may be stopped.
- If a notebook computer that is not connected to an electrical outlet is connected to the camera, the battery of the notebook computer will be depleted. Do not leave the camera and notebook connected for a long period of time.
- Always connect the USB connection cable to the USB connector on your computer. Do not connect the USB connection cable to the USB connector of the monitor, keyboard, printer, or USB hub.

■ Charging lamp indications

On: Charging in progress

Off: Charging stops (After charging stops, disconnect the camera from the electrical outlet or your computer.)

■ Notes on charging time

When using the AC adaptor (supplied)

Charging time	Approx. 120 min
----------------------	-----------------

- The charging time indicated above is the time required for charging in the case when the battery is completely used up. The time required for charging differs depending on conditions of battery usage. Charging takes longer in cases when temperatures are either high or low and when the battery has not been used for a long period of time.
- The time required for charging through the computer varies depending on the specifications of the computer.

- Do not use any other USB connection cables except the supplied one or a genuine Panasonic USB connection cable (optional). Using cables other than them may cause a malfunction.
- Do not use a USB extension cable.
- Do not use any other AC adaptors except the supplied one.
- The AC adaptor (supplied) and the USB connection cable (supplied) are dedicated accessories of this camera. Do not use them for other devices.
- If there is any trouble related to the electrical outlet (i.e. power failure), charging may not complete properly. Disconnect the USB connection cable (supplied) and reconnect it to the camera.
- If the charging lamp does not light or flashes even when the camera is properly connected to the AC adaptor (supplied) or your computer, charging has been put in pause status because the temperature is not in the appropriate range for charging. This is not a malfunction. Reconnect the USB connection cable (supplied) and retry charging in a place where ambient temperature is 10 °C to 30 °C (50 °F to 86 °F) (temperature conditions also apply to the battery itself).

Remaining battery

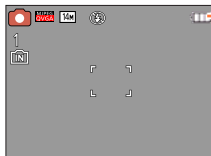

Remaining battery



(flashes red)

If the battery mark flashes red, recharge or replace battery.

Guidelines for number of recordable pictures and operating time

The number of recordable pictures or available operating time may vary according to surrounding environment and usage conditions. Figures may be reduced if flash, zoom, or other functions are used frequently, or in colder climates.

■ Recording still pictures

Number of recordable pictures	Approx. 250 pictures	By CIPA standard
Recording time	Approx. 125 min	

● Recording conditions by CIPA standard

CIPA is an abbreviation of [Camera & Imaging Products Association].

- [Normal Picture] Mode
- Temperature: 23 °C (73.4 °F)/Humidity: 50%RH when LCD monitor is on.
- Using a Panasonic SD Memory Card (32 MB).
- Using the supplied battery.
- Starting recording 30 seconds after the camera is turned on.
- Recording once every 30 seconds with full flash every second recording.
- Perform a zoom operation every recording (W end → T end, or T end → W end).
- Turning the camera off every 10 recordings and leaving it until the temperature of the battery decreases.

Number reduced if intervals are longer (e.g. to approx. one quarter for 2-minute intervals under the above conditions).

■ Recording motion pictures*1

[Rec Quality]	[HD]
Available recording time	Approx. 90 min
Actual available recording time*2	Approx. 45 min

● Recording conditions

- Temperature 23 °C (73.4 °F), humidity 50%RH

*1 Motion pictures can be recorded continuously up to 2 GB.

The maximum available recording time for up to 2 GB only is displayed on the screen.

*2 The time you can actually record when repeatedly turning the camera on and off, starting and stopping recording and using zoom.

■ Viewing pictures

Playback time	Approx. 300 min
---------------	-----------------

Inserting and removing the card (optional)

- 1 Turn off the camera and slide the card/battery door out (①) before opening the door (②) as illustrated

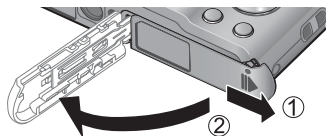

- 2 Insert the card all the way
 - Check orientation: terminals face LCD
 - Push in until it clicks.



- 3 Close the card/battery door and slide the door in until you hear a locking sound

■ To remove card

Press the center of the card

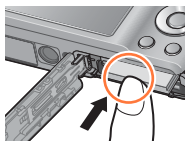

- Keep the Memory Card out of reach of children to prevent swallowing.
- To remove the card, turn the camera off and wait until the LUMIX indicator on the LCD monitor goes off. (Failure to wait may cause the camera to malfunction and may damage the card or recorded data.)

About built-in memory/cards

Saving your pictures (cards and built-in memory)

Pictures will be saved to a card if one is inserted, or to the built-in memory  if not.

■ Built-in memory (approx. 10 MB)

- Pictures may be copied between cards and the built-in memory. (→70)
- The access time for the built-in memory may be longer than the access time for a card.

■ Compatible memory cards (optional)

The following SD standard-based cards (Panasonic brand recommended)

Type of Card	Capacity	Notes
SD Memory Cards	8 MB – 2 GB	<ul style="list-style-type: none">• Use a card of SD Speed "Class 6"* or higher for recording motion pictures.• Can be used with devices compatible with the respective formats.• Before using SDXC Memory Cards, check that your computer and other devices support this type of card. http://panasonic.net/avc/sdcard/information/SDXC.html• Only the cards listed on the left with the given capacities are supported.
SDHC Memory Cards	4 GB – 32 GB	
SDXC Memory Cards	48 GB, 64 GB	

* SD speed class refers to a specification for sustained write speeds. Confirm the SD speed by checking the card label or other card related materials.

(Example)



- While the camera is accessing the card or built-in memory (for an operation such as picture writing, reading, deletion, or formatting), do not turn off the camera or remove the battery, card, or AC adaptor (supplied). Do not subject the camera to vibrations, impact, or static electricity. Should any of these cause camera operation to be terminated, attempt to perform the operation again.
- Please reformat the card with this camera if it has already been formatted with a computer or another device. (→41)
- If the write-protect switch is set to "LOCK", the card cannot be used to record or delete pictures, and it cannot be formatted.
- It is recommended that you copy important pictures to your computer (as electromagnetic waves, static electricity, or faults may cause data to be damaged).
- Latest information:
<http://panasonic.jp/support/global/cs/dsc/>
(This site is available in English only.)



Switch

Recording capacity guidelines (pictures/recording time)

The number of pictures you can take and the recording time vary in proportion to card capacity (and depending on recording conditions and type of card).

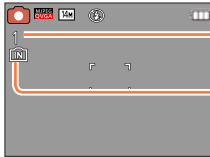

Estimated remaining pictures or recording time capacity
(press ▼ to switch display)

Displayed when no card is inserted
(pictures will be saved to built-in memory)

■ Recording picture capacity (still pictures)

[Picture Size]	Built-in memory	2 GB	32 GB	64 GB
4:3 14M	1	280	4650	9280
4:3 5M	6	1050	17130	32910
4:3 0.3M	85	15000	247890	430430

- When the number of recordable pictures exceeds 99,999, "+99999" is displayed.

■ Recording time capacity (motion pictures)

[Rec Quality]	Built-in memory	2 GB	32 GB	64 GB
HD	–	10m40s	3h03m	6h06m
VGA	–	23m20s	6h19m	12h36m
QVGA	19s	1h02m	16h44m	33h23m

([h], [m] and [s] indicate "hour", "minute" and "second".)

- Motion pictures can be recorded continuously up to 2 GB.
The maximum available recording time for up to 2 GB only is displayed on the screen.

Setting the clock

The clock is not set when the camera is shipped.

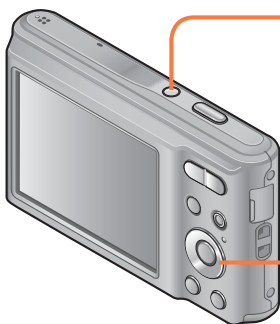

1 Press the Camera [ON/OFF] button

The camera is turned on.
If the language select screen is not displayed, proceed to step 4.



2 Press [MENU/SET] while the message is displayed

3 Press ▲ ▼ to select the language, and press [MENU/SET]

4 Press [MENU/SET]

5 Press ◀ ▶ to select the items (year, month, day, hour, minute, display order or time display format), and press ▲ ▼ to set

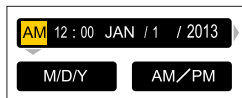

• To cancel → Press [↵] button.

6 Press [MENU/SET] to set

7 Press [MENU/SET]

• To return to the previous screen, press [↵] button.

Changing time setting

When resetting date and time, select [Clock Set] from the [Setup] menu or [Rec] menu.

- Clock settings will be saved for approx. 24 hours even after the battery is removed, provided a fully charged battery was installed in the camera for 5 hours beforehand.

1 Select [Clock Set] from the [Setup] menu or [Rec] menu (→37)

2 Press ◀▶ to select the items (year, month, day, hour, minute, display order or time display format), and press ▲▼ to set



- To cancel → Press [↵] button.

3 Press [MENU/SET] to set

- If the clock is not set, the correct date cannot be printed.
- If the clock is set, the correct date can be printed even if the date is not displayed on the screen of the camera.

Sequence of operations

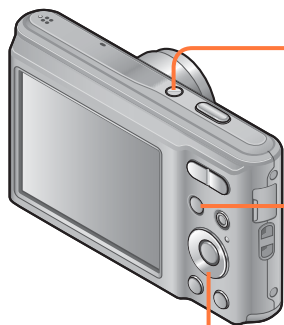

1 Press the Camera [ON/OFF] button





2 Press [MODE] button



3 Use cursor button to select the recording mode and press [MENU/SET]



	[Auto Scene Mode]	Take pictures with automatic settings. (→24)
	[Normal Picture] Mode	Take pictures with your own settings. (→27)
	[Panorama Shot] Mode	Take panorama pictures. (→49)
SCN	[Scene Mode]	Take pictures according to scene. (→52)

(Continued on the next page)

Aim the camera and shoot

■ Taking still pictures

- ① Press the shutter button halfway to focus
- ② Press and hold the shutter button to take the picture

■ Recording motion pictures (→29)

- ① Press the motion picture button to start recording
- ② Press the motion picture button again to finish recording

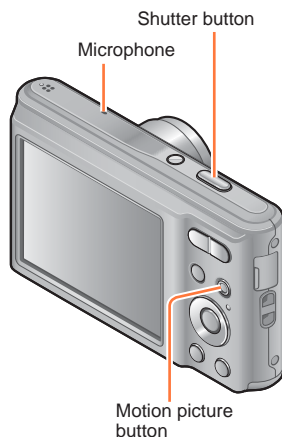

4

■ Holding the camera

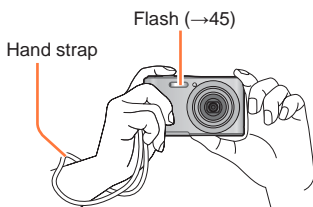

- To avoid camera shake, hold it with both hands keeping your arms close to your body while standing with your feet slightly apart.
- Do not touch the lens.
- Do not block the microphone when recording motion pictures.
- Do not put your hands over the light-emitting area of the flash or look at it from close range.
- Make sure that the camera does not move at the moment the shutter button is pressed.

- We recommend using the supplied hand strap to avoid dropping the camera.

(Continued on the next page)

Press the Playback button

5

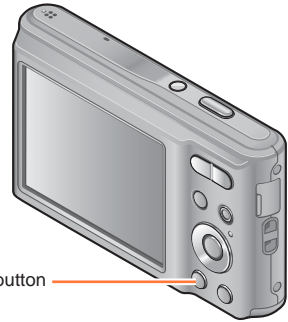

Playback button

View pictures (→31, 34, 51)

6

- Press ◀▶ to select a picture
- Press ▲ to play back motion pictures or panorama pictures (→49)

■ Taking pictures once again

- Press Playback button to enter the recording mode

Turn off the camera (Press the Camera [ON/OFF] button)

7

Taking pictures with automatic settings

[Auto Scene Mode]

Recording mode: **A**   SCN

Optimum settings are made automatically from information such as “face”, “movement”, “brightness”, and “distance” just by pointing the camera at the subject, meaning that clear pictures can be taken without the need to make settings manually.

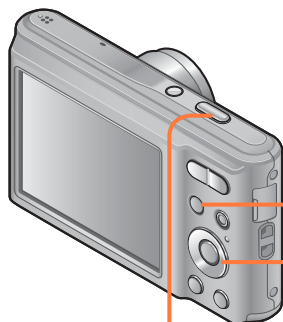

1 Press [MODE] button to display the recording mode selection screen

2 Use cursor button to select **A** [Auto Scene Mode] and press [MENU/SET]

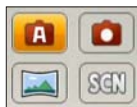

3 Take a picture



Press halfway
(press lightly to focus)



Press fully
(press the button all the way to record)



Focus display
(When focus is aligned:
illuminated
When focus is not
aligned: flashing)

■ Recording motion pictures in **A** (→29)

Using flash

Press ► to select **i/A** or **☺**.

- When **i/A** is selected, the optimum flash (**i/A**, **i/A**, **i/S**, **i/S**) is selected automatically depending on conditions. (→46)
- When **i/A** or **i/S** is selected, the red-eye reduction function is activated.
- When **i/S** or **i/S** is selected, the shutter speed is reduced.

Automatic Scene Detection

Camera reads scene when pointed at subject, and makes optimum settings automatically.

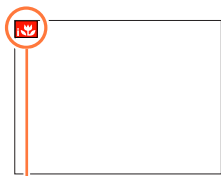

The icon of scene detected

	Recognizes people
	Recognizes landscapes
	Recognizes night scenes and people in them (Only when i/A is selected)*
	Recognizes night scenes*
	Recognizes close-ups
	Recognizes sunsets
	Reads subject movement to avoid blurring when scene does not correspond to any of the above.

* We recommend using a tripod and the self-timer.

- Depending on recording conditions, different scene types may be determined for the same subject.
- If desired scene type is not selected, we recommend manually selecting the appropriate scene mode.
- When **i/S** or **i/S** is detected, Face Detection is activated, and the focus and exposure are adjusted to the recognized faces.

■ About Backlight Compensation

Backlight compensation is automatically activated in [Auto Scene Mode]. Backlight is a condition where a light shines from behind a subject. When there is a backlight, the subject appears darker and the camera will automatically attempt to correct it by increasing the brightness of the picture.

[Auto Scene Mode] restrictions

Only the menu items that are displayed in the [Auto Scene Mode] can be set. The settings selected in the [Normal Picture] or other modes will reflect on the menu items in the [Setup] menu that are not displayed.

- The settings for the following items are different from other recording modes:
[Picture Size] on the [Rec] menu

- The settings for the following functions are fixed:

[Setup] menu

- [Auto Review]: [ON]
- [Auto Power Off]: [5MIN.]

[Rec] menu

- [Sensitivity]: [ISO]
- [AF Mode]:  [Face Detection]*
- [Red-Eye Removal]: [ON]
- [White Balance]: [AWB]

*  (9-area-focusing) when face cannot be recognized

- The following functions cannot be used:
[Exposure], [Digital Zoom]

Taking pictures with your own settings

[Normal Picture] Mode

Recording mode:    SCN

Using the [Rec] menu to change settings and set up your own recording environment.

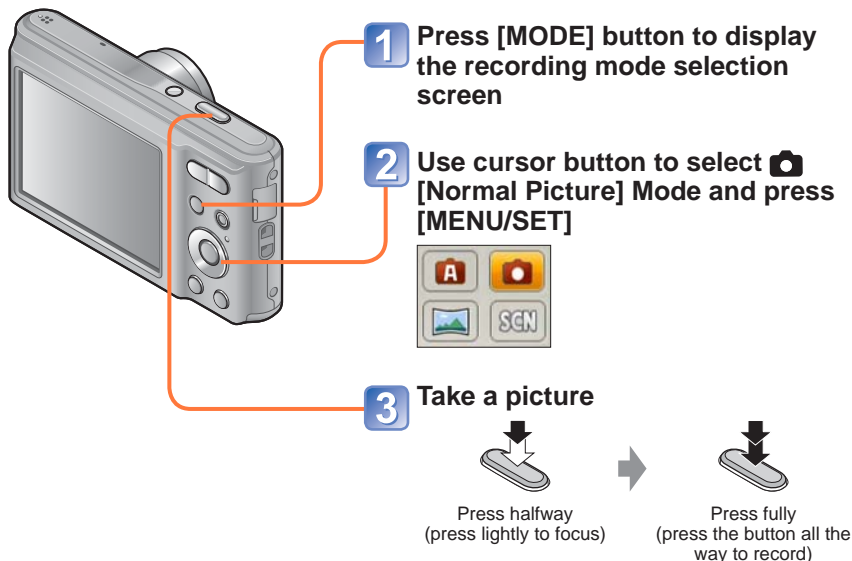

■ Recording motion pictures in (→29)

- If a warning is displayed about jitter, use a tripod or [Selftimer].
- If aperture and shutter speed are shown in red, you do not have appropriate exposure. You should either use the flash or change [Sensitivity] settings.

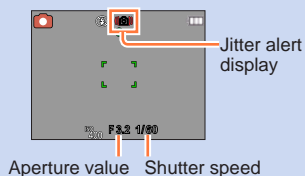

Adjusting focus

When [AF Mode] is set to  (1-area-focusing), focus on the AF area in the center of the picture. If a subject you want to record is not in the center, follow the steps below.

1 Adjust focus according to subject

Align the AF area with the subject



Hold down halfway

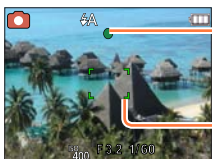

Focus display

(When focus is aligned: illuminated
When focus is not aligned: flashing)

AF area

(When focus is aligned: green
When focus is not aligned: red)

2 Return to desired composition



Press fully



AF area

■ Shortest recording distance

Zoom position	The shortest focusing distance from the surface of the lens
W end	10 cm (0.33 feet)
T end	1 m (3.3 feet)

When the zoom is operated from the W (wide-angle) end to the T (telephoto) end, the shortest focusing distance changes in stages.

- Subjects/environments which may make focusing difficult:
 - Fast-moving or extremely bright objects, or objects with no color contrast.
 - Taking pictures through glass or near objects emitting light. In dark, or with significant jitter.
 - When too close to object or when taking pictures of both distant and close objects together in the same picture.
- The focus display flashes and beep sounds when focus is not aligned. Use the focus range displayed in red as a reference. (→43)
Even if the focus display is lit, the camera may be unable to bring the subject into focus if it is out of range.
- The AF area display may be larger depending on recording conditions such as dark locations or zoom ratio.

Recording motion pictures

Recording mode:

You can record motion pictures with audio (monaural).

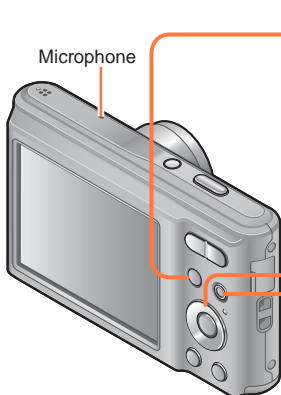

1 Press [MODE] button to display the recording mode selection screen

2 Use cursor button to select the desired recording mode and press [MENU/SET]

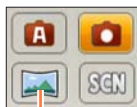

• Motion pictures cannot be recorded in [Panorama Shot] Mode (A).

3 Press the motion picture button to start recording

[Rec Quality] (→63)



Elapsed recording time

Remaining recording time (approx.)

- Immediately release the motion picture button after pressing it.
- You can use digital zoom even while recording motion pictures.
 - Set the [Digital Zoom] to [ON] beforehand.
 - You cannot use the zoom while recording motion pictures in the following cases:
 - [Auto Scene Mode]
 - [High Sens.] Scene Mode

4 Press the motion picture button again to end recording

(Continued on the next page)

■ Recording motion pictures in

A motion picture will be recorded without Automatic Scene Detection operating.

■ Recording motion pictures in

Records a motion picture at your preferred settings.

- Aperture and shutter speed are automatically set.

■ Recording motion pictures in SCN

Records a motion picture at the optimum settings for the selected scene.

- Some scenes are switched to the following scenes:

Selected scene	Scenes for motion picture
[Baby]	Portrait motion picture
[Night Portrait] [Night Scenery]	Low light motion picture
[Sports]	Normal motion picture

- The available recording time displayed on the screen may not decrease regularly.
- If data is repeatedly recorded and deleted, the total available recording time on the SD card may be reduced. To restore the original capacity, use the camera to format the SD card. Be sure to save all important data to your computer or other media before formatting, as all data saved to the card will be erased.
- The following functions are not available:
Extended Optical Zoom, flash.
- For certain memory cards, recording may end while in progress.
- The recording range may become narrower in motion pictures compared to still pictures. Also, if the Aspect Ratio is different for still pictures and motion pictures, the angle of view will change when starting to record a motion picture. The recordable area is displayed by setting [Video Rec Area] (→39) to [ON].
- If Extended optical zoom is used before pressing the motion picture button, these settings will be cleared, and the recordable area will be changed significantly.
- Depending on the environment when recording motion pictures, the screen may turn black for an instant or noise may be recorded because of static electricity, electromagnetic waves, etc.

Viewing your pictures [Normal Play]

When a card is in the camera, pictures are played back from the card. Without a card, pictures are played back from the built-in memory.



1 Press the Playback button



- Press again to enter the recording mode.

2 Use the ◀▶ cursor button to select a picture that you want to play back

- Hold down to quickly scroll forwards/backwards.

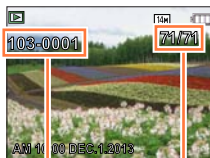

Folder/File number

Picture number/Total pictures

- It may not be possible to view pictures on this camera that were previously edited on a computer.
- After pressing the Playback button and switching it into the playback mode, the lens barrel will be retracted after approx. 15 seconds.
- This camera is compliant with the unified DCF (Design rule for Camera File system) standard formulated by the Japan Electronics and Information Technology Industries Association (JEITA), and with Exif (Exchangeable image file format). Files that are not DCF-compliant cannot be played back.

Zooming in and viewing “Playback Zoom”



Press the T side of the zoom button



Current zoom position (displayed for 1 sec.)



➔ Press the T side of the zoom button

➜ Press the W side of the zoom button

- Move zoom position → ▲▼◀▶

- Playback zoom cannot be used during motion picture playback.

Viewing a list of pictures “Multi Playback”



Press the W side of the zoom button

Picture number/Total pictures



➔ Press the W side of the zoom button

➜ Press the T side of the zoom button

- When you select a picture using the cursor button and press [MENU/SET] on the 12-picture or 30-picture screen, the selected picture is displayed on the 1-picture screen (full-screen).

- Pictures displayed with [!] cannot be played back.

Searching pictures by their recording date "Calendar"



Press the W side of the zoom button several times



Selected date



➡ Press the W side of the zoom button

⬅ Press the T side of the zoom button

- When you select a recording date using the cursor button and press [MENU/SET], the display method changes to the 30-picture screen.

● Only months when pictures were taken are shown on the calendar screen. If the clock was not set, pictures will be displayed as January 1st, 2013. If the date / time was set incorrectly, pictures will be displayed with the incorrect settings.

Viewing motion pictures

- 1** Select a picture with the motion picture icon, and press **▲**
Playback now starts.



Motion picture icon

Motion picture recording time

When playback starts, the elapsed playback time is displayed in the top right of the screen.

Example: After 10 minutes and 30 seconds: [10m30s]

■ Operations during motion picture playback

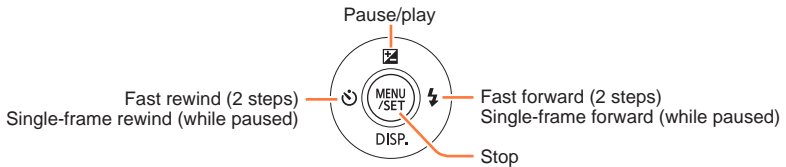

- If **▲** is pressed during fast forward or rewind, it will return to normal playback speed.
- The volume can be adjusted with the zoom button.

- It may not be possible to properly play back the motion pictures recorded using other cameras.
- Motion pictures can be viewed on your computer using "PHOTOfunSTUDIO" on the supplied CD-ROM.

Deleting pictures

Pictures will be deleted from the card if the card is inserted, or from the built-in memory if the card is not inserted. (Deleted pictures cannot be recovered.)



1 Press to delete displayed picture



- A confirmation screen is displayed. Select [Yes] with cursor button and then press [MENU/SET].

- Do not turn off the camera during deletion.
- Pictures cannot be deleted in the following cases:
 - Protected pictures
 - Card switch is in "LOCK" position.
 - Pictures not of DCF standard (→31)

To delete multiple (up to 50)/To delete all pictures

1 Press [] while viewing a picture



2 Use ▲ ▼ to select [Delete Multi]/[Delete All] and press [MENU/SET]

■ [Delete Multi]

- ① Use cursor button to select picture and press [MENU/SET].
 - To cancel → Press [MENU/SET] again.
- ② Use cursor button to select [OK] and press [MENU/SET].



 Picture selected

- A confirmation screen is displayed. Select [Yes] with cursor button and then press [MENU/SET].
- May take time depending on number of pictures deleted.

Setting the menu

Refer to the procedure below for an example on how to operate the menus.

Example: Changing [AF Mode] in the [Rec] menu in [Normal Picture] Mode

1 Press [MENU/SET]

The menu selection screen is displayed.

2 Press ◀▶ to select [Rec] menu and press [MENU/SET]

3 Press ▲▼ to select [AF Mode] and press [MENU/SET]

Ⓐ: Pages

The pages can also be selected with the zoom button.

Ⓑ: Menu description

Ⓒ: Menu items

Ⓓ: Operation guide

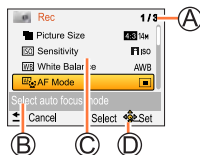

4 Press ▲▼ to select a setting, and then press [MENU/SET]

The selected setting is set.

• To cancel → Press [↵] button.

Ⓔ: Settings

Ⓕ: Selected setting

Ⓖ: Setting description

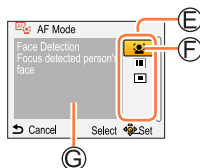

5 Press [↵] button until the menu closes and the monitor returns to the previous screen

The screen changes each time you press the button.

- The operation screen examples in this manual may differ from the actual screen display or some parts of the screen display are omitted.
- The menu types and items that are displayed vary according to the mode.
- The setting methods vary depending on the menu item.
- Press the shutter button halfway to exit the menu and enter the recording screen.

Menu type

[Rec] menu

(In recording mode only)

Changing picture preferences (→56)

- Enables you to set the coloring, picture size, and other items.

[Motion Picture] menu

(In recording mode only)

Recording motion pictures using your own settings (→63)

- You can select the picture quality.

[Setup] menu

Making the camera more convenient to use (→39)

- Enables you to specify clock settings, sound volume, and so on to make the camera easier to use.

[Playback] menu

(In playback mode only)

Using your pictures (→67)









- Enables you to specify picture protection, resizing, and other settings for pictures you have taken.

- The following menu is also displayed depending on the recording mode.
 - In the Scene Mode: Scene menu (→52)





Using the [Setup] menu

[Clock Set], [Auto Power Off] and [Auto Review] are important for clock setting and battery life. Please check these before use.



- For details about the setting procedure in the [Setup] menu (→37)

Item	Settings, notes
 [Clock Set] (→19, 20)	Set time, date, and display format.
 [Beep] Change or mute the beep/shutter sounds.	 /  /  : Low / High / Mute
 [Volume] Adjust volume of sound from speakers (7 levels).	[0] / [1] / [2] / [3] / [4] / [5] / [6]
 [Video Rec Area] Enables verification of the recordable area for a motion picture before recording.	[ON] / [OFF] <ul style="list-style-type: none"> • Recordable area displayed for motion pictures should be interpreted as a guideline. • When using Extended Optical Zoom, the recordable area may not always be displayed for certain zoom ratios.
 [Auto Power Off] Turn off the camera when you are not using the camera to minimize battery consumption.	[2MIN.] / [5MIN.] / [10MIN.] / [OFF]: Automatically shut off camera while not in use. <ul style="list-style-type: none"> • To restore → Press the Camera [ON/OFF] button. • Cannot be used in the following cases: When connected to computer/printer, during motion picture recording/playback, during Slide Shows • Settings are fixed to [5MIN.] in [Auto Scene Mode]

- For details about the setting procedure in the [Setup] menu (→37)

Item	Settings, notes
 [Light Freq.] Correct flickers on the LCD monitor.	[50Hz] / [60Hz] <ul style="list-style-type: none"> • If the LCD monitor flickers when you record pictures under lighting such as fluorescent or LED lighting, set the utility frequency of the area where you are using the camera.
 [Auto Review] Automatically display still pictures immediately after taking them.	[ON] (Automatically displays for 2 seconds.) / [OFF] <ul style="list-style-type: none"> • [Auto Review] is activated regardless of its setting in the following cases. <ul style="list-style-type: none"> - [Auto Scene Mode] - [Burst] mode • Motion pictures cannot be automatically reviewed.
 [Reset] Reset to the default settings.	[Reset Rec. settings?] [Reset setup parameters?] <ul style="list-style-type: none"> • When [Setup] settings are reset, [Age] setting in [Baby] Scene Mode is also reset. • Folder numbers and clock settings will not be reset.
 [Version Disp.]	Current version is displayed.

- For details about the setting procedure in the [Setup] menu (→37)

Item	Settings, notes
<p> [Format]</p> <p>Use when [Built-In Memory Error] or [Memory Card Error] appears, or when formatting the built-in memory or card.</p> <p>When a card/built-in memory is formatted, the data cannot be restored. Check the content of the card/built-in memory carefully before formatting.</p>	<ul style="list-style-type: none"> • When formatting the built-in memory, remove the cards. (Only inserted card will be formatted if present; built-in memory will be formatted if no card is inserted.) • Always format cards with this camera. • All protected pictures and other picture data will be deleted. • Do not turn off the camera or perform other operations during formatting. • Formatting the built-in memory may take several minutes. • If the card cannot be formatted, please try another card before contacting your nearest Service Center. <p>For USA and Puerto Rico assistance, please call: 1-800-211-PANA(7262) or, contact us via the web at: http://www.panasonic.com/contactinfo</p> <p>For Canadian assistance, please call: 1-800-99-LUMIX (1-800-995-8649)</p>
<p> [Language]</p> <p>Change display language.</p>	<p>Set the language displayed on the screen.</p>

Changing recording information display

You can switch between the various types of information shown on the LCD monitor, such as recording information.

1 Press ▼ to change display



■ In Recording Mode

Recording information,
Number of recordable
pictures



Recording information,
Available recording time



No display



* When pressing the shutter button halfway.

■ In Playback Mode

Picture
information



Recording
information



No display



- During Motion Picture Playback, Panorama Playback, Slide Show:
You can only turn on and turn off the display.
- During menu display, Multi Playback or [Calendar]:
Display cannot be changed.

Using Zoom

Recording mode:    

You can adjust the area of a picture to be taken using zoom.

1 Zoom In/Out

Capture a wider area
(wide-angle)



Enlarge the subject
(telephoto)

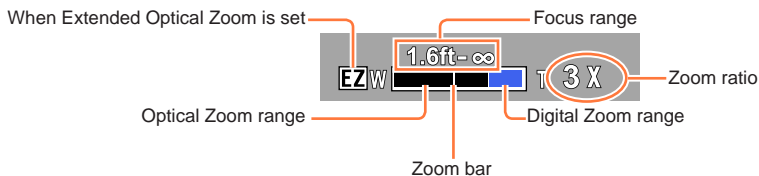

- Adjust the focus after adjusting the zoom.
- The zoom ratio and the zoom bar displayed on the screen are estimates.

Zoom types and use

The zoom ratio changes when the picture size is changed. (→56)

■ Optical Zoom

Zooming in up to 5x is possible if pictures without **EZ** have been selected by [Picture Size] on the [Rec] menu.

■ Extended Optical Zoom

Zooming in up to 10.5x is possible when pictures with **EZ** have been selected by [Picture Size] on the [Rec] menu.

EZ is short for “Extended Optical Zoom”.

- Extended Optical Zoom cannot be used in the following cases:
 - Motion picture
 - Scene Mode ([High Sens.])

To increase the zoom ratio further, the following zoom can be used in combination.

■ [Digital Zoom]

Zoom 4x further than Optical/Extended Optical Zoom. Note that, with Digital Zoom, enlarging will decrease picture quality. Set the [Digital Zoom] in the [Rec] menu to [ON]. (→60)







- Digital Zoom cannot be used in the following cases:
 - [Auto Scene Mode]
 - Scene Mode ([High Sens.])

Taking pictures with flash

Recording mode:    



1 Press  to display [Flash]

2 Use cursor button to select the desired type and press [MENU/SET]

Type, operations	Uses
 [Auto]  *1 • Automatically judges when to use flash	Normal use
 [Auto/Red-Eye]*2 • Automatically judges when to use flash (reduce red-eye)	Taking pictures of subjects in dark places
 [Forced Flash On] • Always flash	Taking pictures with backlight or under bright lighting (e.g. fluorescent)
 [Slow Sync./Red-Eye]*2 • Automatically judges when to use flash (reduce red-eye; slow shutter speed to take brighter pictures)	Taking pictures of subjects against a nightscape (tripod recommended)
 [Forced Flash Off] • Never flash	Places where flash use is prohibited

*1 Only in the  mode

*2 Two flashes will be emitted. Do not move until after the second flash.

If [Red-Eye Removal] on the [Rec] menu is [ON], the  appears with the flash icon, red-eye is automatically detected and still picture data is corrected. (Only when [AF Mode] is  (Face Detection))

■ The available flash range when [Sensitivity] setting is [ISO]

Max. Wide	Approx. 60 cm - 5.7 m (2.0 feet - 19 feet)
Max. Tele	Approx. 1.0 m - 2.8 m (3.3 feet - 9.2 feet)

- Do not put your hands over the light-emitting area of the flash (→8) or look at it from close range.
Do not use the flash at close distances to other subjects (heat/light may damage subject).

Available types in each mode (○: Available, –: Not available, : Default setting)

	A		[Scene Mode]					
	○*1	○	○	<input type="checkbox"/>	–	○	○	○
	–	○	<input type="checkbox"/>	–	–	–	<input type="checkbox"/>	–
	–	○	○	○	–	○	○	○
	–	–	–	–	<input type="checkbox"/>	–	–	–
	○	○	○	○	○	<input type="checkbox"/>	○	<input type="checkbox"/>

*1 Set to , , or depending on the subject and brightness.

- The flash cannot be used in the following cases:
 - Recording motion pictures
 - , and Scene Modes
 - [Panorama Shot] Mode

Shutter speeds for each flash mode

	1/60*2 - 1/2000th
	1*2 - 1/2000th

*2 Differs for each mode other than mode.

- The effect of red-eye reduction varies depending on the subject and is affected by factors such as distance to the subject, whether the subject is looking at the camera during preliminary flash, and so on. In some cases, the effect of red-eye reduction may be negligible.
- Flash settings may be changed when changing recording mode.
- Scene Mode flash settings are restored to default when Scene Mode is changed.
- No pictures may be taken if these marks (e.g.) are flashing (flash is charging).
- If light from the flash on a subject is insufficient, neither the proper exposure nor White Balance is achieved.
- Flash charging may take time if battery is low or if using flash repeatedly.
- The flash effect may not be sufficient when [Flash Burst] is set.

Taking pictures with self-timer

Recording mode:    

We recommend using a tripod. This is also effective for correcting jitter when pressing the shutter button, by setting the self-timer to 2 seconds.

1 Press **◀** to display [Selftimer]

2 Use cursor button to select time duration and press [MENU/SET]

3 Take a picture

Press the shutter button fully to start recording after the preset time.



Self-timer indicator
(Flashes for set duration)

- To cancel while in operation → Press [MENU/SET]

● You cannot use the self-timer for motion picture recording.

Taking pictures with Exposure Compensation

Recording mode:    

This feature allows the user to manually adjust the exposure when a proper auto exposure cannot be obtained.

1 Press **▲** to display [Exposure]

2 Use cursor button to select a value and press [MENU/SET]

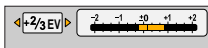

- If the picture is too dark, adjust the exposure to the “+” direction.
- If the picture is too bright, adjust the exposure to the “-” direction.
- After exposure adjustment, the adjustment value ( for example) is displayed in the bottom-left corner of the screen.

- Depending on the brightness, this may not be possible in some cases.
- The Exposure Compensation value you set is retained even after the camera is turned off.

Taking panorama pictures [Panorama Shot] Mode

Recording mode:      SCN

Creates a single panorama picture by stitching multiple still pictures taken in rapid succession.

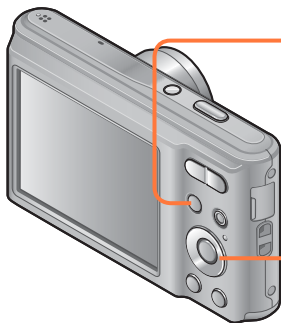

1 Press [MODE] button to display the recording mode selection screen

2 Use cursor button to select  [Panorama Shot] Mode and press [MENU/SET]

3 Use cursor button to select the recording direction, and press [MENU/SET] to set

4 Check the recording direction and press [MENU/SET]

Special panorama guidelines will be displayed during recording.

- You can go back to step **3** by pressing  and selecting the recording direction again.

5 Press the shutter button halfway to focus

6 Press the shutter button fully and pan the camera in a small semi-circular motion in the selected direction to start recording

(Example) Taking pictures from left to right

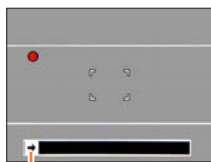

Recording direction and progress status (approximate)

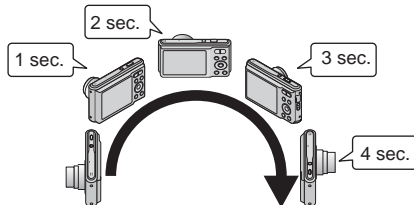

- Pan the camera so that you make a semicircle in approx. 4 seconds.
 - Pan the camera at a constant speed.
 - You may not be able to take pictures successfully if you move the camera too quickly or too slowly.

(Continued on the next page)

7 Press the shutter button fully again to end recording

You can also end recording if you stop panning the camera while taking pictures.

■ Tips

- Pan the camera in the recording direction as steadily as possible.

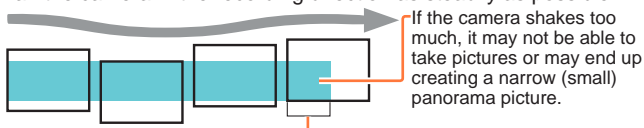

The subjects that are displayed in this range are recorded. (guideline)

- The zoom position is fixed to the max. Wide.
- The focus, exposure and White Balance are all fixed to optimal values for the first picture.
If the focusing or brightness of pictures recorded as part of a Panorama picture after the first picture are significantly different from those of the first picture, the Panorama picture as a whole (when all pictures are stitched together) may not have consistent focus and brightness.
- The following functions are fixed to the settings indicated below.
[Digital Zoom]: [OFF] [Date Stamp]: [OFF] [Burst]: [OFF]
- Following [Rec] menu settings will be automatically adjusted and cannot be selected manually.
[Sensitivity], [Color Mode]
- Since several pictures are stitched together to create a Panorama picture, some subjects may be distorted or the joining portions of successively taken pictures that are stitched may be noticeable.
- The number of recording pixels per horizontal line and vertical line of a Panorama picture varies depending on the recording direction and number of stitched pictures. The maximum number of recording pixels is as follows:
 - Taking pictures in landscape orientation: Approx. 3200x720
 - Taking pictures in portrait orientation: Approx. 960x3200
- Panorama pictures may not be created or pictures may not be recorded properly when taking pictures of the following subjects or when taking pictures in the following recording conditions:
 - Subjects that have a continuous monotone or pattern (sky, beach, etc.)
 - Moving subjects (person, pet, vehicle, waves, or flowers swaying in the wind, etc.)
 - Subjects whose colors or patterns change quickly (such as an image appearing on a display)
 - Dark locations
 - Locations with a flickering light source (fluorescent lamp, candle light, etc.)

(Continued on the next page)

■ About panorama playback

You can operate the zoom button to enlarge still pictures taken in [Panorama Shot] mode in the same way as with other still pictures (Playback Zoom →32). You can also press ▲ to automatically scroll pictures in the same way as when playing back a motion picture (Motion Picture Playback →34).

- Unlike motion picture playback, you cannot perform fast forward or rewind by pressing ◀ or ▶ while the pictures are scrolling automatically. (You can perform single-frame forward or rewind while the automatic scrolling operation is paused.)

Taking pictures according to the scene

[Scene Mode]

Recording mode:     SCN

Using [Scene Mode] enables you to take pictures with optimum settings (exposure, coloring, etc.) for given scenes.

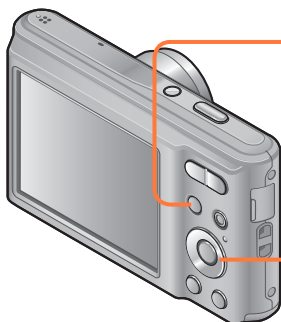

- 1** Press [MODE] button to display the recording mode selection screen
- 2** Use cursor button to select SCN [Scene Mode] and press [MENU/SET]
- 3** Use cursor button to select the scene and press [MENU/SET]

■ Changing the selected scene mode ([Scene Mode] menu)

- ① Press [MENU/SET]
- ② Use cursor button to select [Scene Mode] menu and press [MENU/SET]
- ③ Use cursor button to select the scene and press [MENU/SET]

■ Recording motion pictures in SCN (→29)

Records a motion picture at the optimum settings for the selected scene.

- Selecting a Scene Mode inappropriate for the actual scene may affect the coloring of your picture.
- Following [Rec] menu settings will be automatically adjusted and cannot be selected manually.
[Sensitivity], [Color Mode]
- Using flash in Scene Modes (→46)

- How to select a scene (→52)
- Using flash in Scene Modes (→46)

[Portrait]

Improves the skin tone of subjects for a healthier appearance in bright daylight conditions.

■ Tips

- The closer the zoom is positioned to the T (telephoto) edge and the closer the camera is brought to the subject, the greater the effect will be.

[Scenery]

Takes clear pictures of wide, distant subjects.

[Sports]

Takes pictures of scenes with fast movement, e.g. sports.

■ Tips

- Stand at least 5 m (16 feet) away.

- How to select a scene (→52)
- Using flash in Scene Modes (→46)

[Night Portrait]

Takes pictures of people and nightscapes with close to actual brightness.

■ Tips

- Use flash.
- Subject should not move.
- Tripod, self-timer recommended.

[Night Scenery]

Takes clear pictures of night scenes.

■ Tips

- Tripod, self-timer recommended.

- Shutter speed may slow down up to 8 seconds.
- After recording, the shutter may stay closed (up to 8 seconds) to process the signal. This is not a malfunction.

[Food]

Takes natural-looking pictures of food.

- How to select a scene (→52)
- Using flash in Scene Modes (→46)

[Baby]

Taking pictures of a baby with a healthy complexion.

- 1 Use cursor button to select [Age] and press [MENU/SET]**
- 2 Use cursor button to select [SET] and press [MENU/SET]**
- 3 Set birthday with cursor button, and press [MENU/SET]**
- 4 Use cursor button to select [Exit] and press [MENU/SET]**

■ Tips

- Make sure [Age] is [ON] before taking a picture.

● [Age] print setting can be made on your computer using "PHOTOfunSTUDIO" on the supplied CD-ROM.

[Sunset]

Takes clear pictures of scenes such as sunsets.

[High Sens.]

Prevents blurring of subject in dark, indoor conditions.

- 1 Select the aspect ratio and the picture size with cursor button and press [MENU/SET]**

Using the [Rec] menu

- For [Rec] menu setting procedures (→37)

[Picture Size]

Set the size (number of pixels) of still pictures. Number of pictures which can be recorded depends on this setting.

■ Recording mode:    

■ Settings:

Recording pixel level type		
4:3	14M	4320x3240
4:3	10M EZ *	3648x2736
4:3	5M EZ	2560x1920
4:3	3M EZ *	2048x1536
4:3	0.3M EZ	640x480
3:2	12.5M	4320x2880
16:9	10.5M	4320x2432
1:1	10.5M	3232x3232

* This setting is not available in **A** ([Auto Scene Mode]).

- **4:3** **3:2** **16:9** **1:1** represent the aspect ratios of the still pictures.
- Mosaic effect may appear depending on subject and recording conditions.

Setting guide

Larger picture size	←→	Smaller picture size
Sharper		Less detailed
Lower recording capacity		Higher recording capacity

- For [Rec] menu setting procedures (→37)

[Sensitivity]

Set ISO Sensitivity (sensitivity to lighting) manually.

We recommend higher settings to take clear pictures in darker locations.

■ **Recording mode:**    SCN

■ **Settings:** **I**ISO [Intelligent ISO] / [100] / [200] / [400] / [800] / [1600]

Setting guide





[Sensitivity]	[100] ←→ [1600]
Location (recommended)	Bright (outdoors) Dark
Shutter speed	Slow Fast
Interference	Low High
Subject blur	High Low

- **I**ISO [Intelligent ISO] is automatically set in a range up to 1600 based on subject movement and brightness.
- The [Sensitivity] is automatically set in the following case:
 - When recording motion pictures

- For [Rec] menu setting procedures (→37)

[White Balance]



Adjust the color depending on the light source to ensure natural color.

■ **Recording mode:**    

■ **Settings:** [AWB] (automatic) /  (outdoor, clear sky) /  (outdoor, cloudy sky) /  (outdoor, shade) /  (Incandescent lighting) /  (uses value set in  SET) /  SET (set manually)

- When [AWB] (Automatic White Balance) is set, the coloring is adjusted in accordance with the light source. However, if the scene is too bright or too dark or if other extreme conditions apply, the pictures may appear reddish or bluish. The White Balance may not operate correctly if there is a multiple number of light sources.
- Under fluorescent lighting, LED lighting fixture etc., the appropriate White Balance will vary depending on the lighting type, so use [AWB] or  SET.
- White Balance setting is fixed to [AWB] in the following cases:
 - Scene Modes ([Scenery], [Night Portrait], [Night Scenery], [Food], [Sunset])
- Even if the camera is turned off, the set White Balance is remembered. (If the Scene Mode is changed, the white balance setting returns automatically to [AWB].)

■ Setting White Balance manually (SET)

- ① Select  SET and press [MENU/SET].
- ② Point the camera towards a white object (e.g. paper) and press [MENU/SET].
 - White Balance is set to .
 - It may not be possible to set the correct White Balance if subjects are too bright or too dark. In this case, adjust the brightness and try to set the White Balance again.

(Continued on the next page)

■ [AWB] operational range:

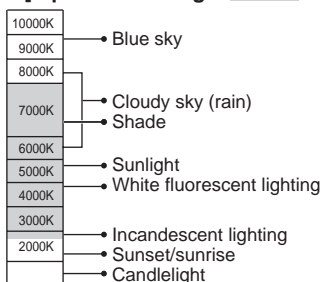



K=Kelvin color Temperature

[AF Mode]



Method of aligning focus can be changed according to position and number of subjects.

■ **Recording mode:**     

■ **Settings:**  /  / 





<p>Taking front-on pictures of people</p> <p> (Face Detection)</p>	<p>Recognizes faces (up to 11 people) and adjusts exposure and focus accordingly.</p> <p>AF area Yellow : When the shutter button is pressed halfway, the frame turns green when the camera is focused. White : Displayed when more than one face is detected. Other faces that are the same distance away as faces within the yellow AF area are also focused.</p>
<p>Subject not centered in picture</p> <p> (9-area-focusing)</p>	<p>Focuses on up to 9 points.</p>
<p>Determined position for focus</p> <p> (1-area-focusing)</p>	<p>Focuses on AF area in center of picture. (Recommended when focus is difficult to align)</p>

(Continued on the next page)

- Cannot set to  (Face Detection) in the following case:
 - Scene Modes ([Night Scenery] [Food])
 - [Panorama Shot] Mode
- If the camera misinterprets a non-human subject as a face in  (Face Detection) setting, switch to another setting.
- If conditions prevent the face from being recognized, such as when the movement of the subject is too rapid, the [AF Mode] setting switches to  (9-area-focusing).

[Digital Zoom]



Zoom 4x further than Optical/Extended Optical Zoom. (Note that enlarging will decrease picture quality with Digital Zoom.)

- Recording mode:    
- Settings: [ON] / [OFF]

- The setting is fixed to [OFF] in the following case:
Scene Mode ([High Sens.])

[Burst]

A burst of still pictures can be recorded while the shutter button is pressed fully.

- Recording mode:    
- Settings:

Setting	Description
 [Burst]	Speed: Approx. 0.5 picture/sec. <ul style="list-style-type: none"> • You can record a series of still pictures successively until the card or built-in memory is full, but at some point the burst speed drops. (The timing at which the burst speed drops varies depending on the type of card and the number of recording pixels.) • When [Selftimer] is set, 3 pictures are taken. • When burst is selected, the flash is unavailable.

(Continued on the next page)

 [Flash Burst]	<ul style="list-style-type: none"> • Number of pictures taken using burst*: maximum of 5 pictures * The number of pictures that can be taken using burst varies depending on the recording conditions and the type of card. • Setting is possible only in [Normal Picture] Mode. • The picture size is fixed to 3M (4:3), 2.5M (3:2), 2M (16:9), or 2.5M (1:1). • The camera fixes its focus along with both exposure and the amount of light to be emitted from a flash, based on the first picture taken. • [Sensitivity] is automatically adjusted. • [Digital Zoom] is fixed to [OFF]. • When [Selftimer] is set, 3 pictures are taken.
[OFF]	The burst function is released.



- Burst speed may be reduced if ISO Sensitivity is set to high, or if shutter speed is reduced in darker locations.
- When you record subjects in motion where there is a significant difference between light and dark areas, it may not be possible to achieve the optimal exposure.



[Color Mode]



Set color effects.

- **Recording mode:**    SCN
- **Settings:** [STANDARD] / [B&W] / [SEPIA]

[Red-Eye Removal]

Automatically detects red-eye and corrects still picture data when recording with flash red-eye reduction ( ).

- **Recording mode:**    SCN
- **Settings:** [ON] / [OFF]

- This setting will work only when [AF Mode] is  (Face Detection).
- The function will turn [OFF] in the following cases:
 - Scene Modes ([Scenery] [Sports] [Night Scenery] [Food] [Sunset] [High Sens.])
- Depending on the circumstance, it may not be possible to correct red-eye.
- When the function setting is [ON], a  appears with the flash icon.

- For [Rec] menu setting procedures (→37)

[Date Stamp]

Still pictures can be taken with the recording date and time stamped on the still picture.

■ **Recording mode:**    

■ **Settings:** [W/O TIME] / [WITH TIME] / [OFF]

- Date stamps on still pictures cannot be erased.
- The date cannot be stamped in the following cases:
 - [Burst]
 - Motion pictures
 - [Panorama Shot] Mode
- Do not request date printing in store or make date printing on printer for still pictures with date stamps. (Date printing may be overlapped.)
- You cannot change the setting in [Auto Scene Mode]. The setting in other Recording Mode is applied.

[Clock Set]

Set the clock. Same function as that in [Setup] menu. (→20)

Using the [Motion Picture] menu

- For [Motion Picture] menu setting procedures (→37)

[Rec Quality]

Set the picture size of motion pictures.

■ Recording mode:    

■ Settings:

Picture Quality	Picture Size	No. of Frames	Picture Aspect Ratio
[HD]	1280x720 pixels	30 fps	16:9
[VGA]	640x480 pixels		4:3
[QVGA]*	320x240 pixels		

* [QVGA] is fixed when recording to the built-in memory.

- Depending on the motion picture recording environment, static electricity or electromagnetic waves may cause the screen to go black momentarily or noise to be recorded.
- If you attempt to play motion pictures recorded with the camera on other devices, playback may not be possible, or the picture or sound quality may be poor. Additionally, incorrect recording information may be indicated.

Different playback methods [Playback Mode]

Recorded pictures can be played back in a variety of ways.

1 Press the Playback button

2 Press [MODE]

3 Use cursor button to select the playback method and press [MENU/SET]

- [Normal Play] (→31)
- [Slide Show] (→65)
- [Category Selection] (→66)
- [Calendar] (→33)

- When no card is inserted, pictures are played back from the built-in memory.
- The [Playback Mode] automatically becomes [Normal Play] when switching from recording mode to playback mode.

- For switching [Playback Mode] (→64)

[Slide Show]

Automatically play pictures in order.

1 Use cursor button to select the playback method and press [MENU/SET]

[All]	Play all.
[Category Selection]	Select category and play back motion or still pictures. (Select category with cursor button and press [MENU/SET].) (→66)

2 Use cursor button to set playback effects and press [MENU/SET]

[Effect]	
[ON] / [OFF]	
[Setup]	
[Duration]	[1SEC.] / [2SEC.] / [3SEC.] / [5SEC.] (Only available when [Effect] is [OFF])
[Repeat]	[ON] / [OFF]

3 Select [Start] with cursor button and press [MENU/SET]

■ Operations during Slide Show

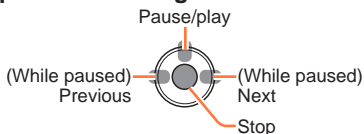













- When panorama pictures are played back, the [Duration] setting is disabled.
- Motion pictures cannot be played back in a Slide Show. The initial screens of motion pictures are played back as still pictures in the Slide Show.

- For switching [Playback Mode] (→64)

[Category Selection]

You can narrow down the pictures displayed to view only a selected category.

1 Select category with cursor button and press [MENU/SET]

	Recording information such as Scene Modes
	[Portrait] /  / [Night Portrait] /  / [Baby]
	[Scenery] /  / [Sunset] / [Panorama Shot] / 
	[Night Portrait] /  / [Night Scenery] / 
	[Sports]
	[Baby]
	[Food]
	[Motion Picture]

[Calendar]

You can specify the recording date to search pictures. (→33)

Using the [Playback] menu

You can edit the picture (for example, resize), and set a protection setting in the picture.

- For [Playback] menu display and operation methods (→37)
- Depending on the [Playback Mode], some [Playback] menu items are not displayed.
- It may not be possible to set or edit pictures taken with other cameras.
- New pictures are created after editing pictures with [Resize]. Before starting to edit, make sure that there is enough free space in the built-in memory or memory card.

[Resize]

Picture size can be reduced to facilitate e-mail attachment and use in web pages, etc. (Still pictures recorded at the smallest recording pixel level cannot be further reduced.)

■[SINGLE]

1 Use cursor button to select [SINGLE] and press [MENU/SET]

2 Use cursor button to select a still picture and press [MENU/SET]

3 Use cursor button to select size and press [MENU/SET]

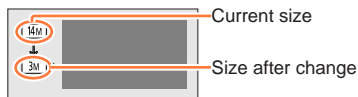

- Confirmation screen is displayed. If you select [Yes], the operation is executed.

(Continued on the next page)

■ [MULTI]

1 Use cursor button to select [MULTI] and press [MENU/SET]

2 Use cursor button to select size and press [MENU/SET]

3 Use cursor button to select a still picture and press [MENU/SET] (up to 50 pictures)



Number of pixels before/after resizing

Resize setting

- To cancel
→ Press [MENU/SET] again.
- To execute
→ Use cursor button to select [OK] and press [MENU/SET].

- Confirmation screen is displayed. If you select [Yes], the operation is executed.

- Picture quality is reduced after resizing.
- Cannot resize the following pictures.
 - Motion pictures
 - Still pictures on which the date has already been stamped
 - Still pictures recorded in [Panorama Shot] Mode

- For [Playback] menu display and operation methods (→37)

[Protect]

Set protection to disable picture deletion. Prevents deletion of important pictures.

1 Use cursor button to select [SINGLE] or [MULTI] and press [MENU/SET]

2 Use cursor button to select picture and press [MENU/SET]

● [SINGLE]

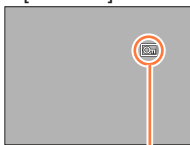

Picture protected

● [MULTI]



Picture protected

- To cancel → Press [MENU/SET] again.

■ To clear all

Select [CANCEL] in step **1** and select [Yes].

- May not be effective when using other devices.

- For [Playback] menu display and operation methods (→37)

[Copy]

You can copy pictures between built-in memory and memory card.

1 Use cursor button to select the copy method (direction) and press [MENU/SET]



: Copy all pictures from built-in memory to card (go to step 3).

: Copy 1 picture at a time from card to built-in memory.

2 Select picture with cursor button and press [MENU/SET]

3 Use cursor button to select [Yes] and press [MENU/SET]

- To cancel → Press [MENU/SET].
- After all the pictures are copied from the built-in memory to the memory card, the display returns automatically to the playback screen.

- Copying pictures may take several minutes. Do not turn off the camera or perform other operations during copying.
- If identical names (folder/file numbers) are present in the copy destination, a new folder for copying will be created when copying from built-in memory to card (). Identically-named files will not be copied from card to built-in memory (.
- The following setting is not copied. Set it again after copying:
 - [Protect]
- Only pictures from Panasonic digital cameras (LUMIX) may be copied.

Using with your PC

Still/motion pictures can be copied from the camera to your computer by connecting the two together.

- Some computers can read directly from the camera's memory card.
For details, see the manual for your computer.
- If your computer does not support SDXC Memory Cards a message will be displayed requesting you to format the card. (Do not format the card. This will erase recorded pictures.) If the card is not recognized, refer to the following support website.
<http://panasonic.net/avc/sdcard/information/SDXC.html>
- You can use pictures copied to your computer for printing, attaching them to e-mail, or other operation. The "PHOTOfunSTUDIO" software on the CD-ROM (supplied) enables you to perform these functions easily.

■ Computer specifications

You can connect the camera to a computer that can detect a mass storage device (device that stores a large volume of data).

- Windows: Windows 8 / Windows 7 / Windows Vista / Windows XP
- Mac: OS X10.1 - 10.8

Using the supplied software

The supplied CD-ROM contains the following software.
Install the software on your computer before using.

■ PHOTOfunSTUDIO 9.0 LE (Windows XP / Vista / 7 / 8)

This software allows you to import still pictures and motion pictures to a PC as well as organize by categorizing them based on their recording date or the model name of the camera used. You can also write pictures to a DVD, retouch and adjust the pictures and edit the motion pictures.

■ LoiLoScope 30 day full trial version (Windows XP / Vista / 7 / 8)

LoiLoScope is a video editing software that draws out the full power of your PC. Creating videos is as easy as organizing cards on top of a desk. Use your music, picture and video files to create videos to share with your friends and family by burning it to a DVD, uploading it to websites, or simply share your videos with your friends via e-mail.

- This will only install a shortcut to the trial version download site.

For more information on how to use LoiLoScope, read the LoiLoScope manual available for download at the link below.

Manual URL: <http://loilo.tv/product/20>

Installing supplied software (PHOTOfunSTUDIO)

Before inserting the CD-ROM, close all running applications.

1 Check the environment of your PC

Operating environment of PHOTOfunSTUDIO 9.0 LE

OS	Windows XP (32 bit) SP3 Windows Vista (32 bit) SP2 Windows 7 (32 bit/64 bit) and SP1 Windows 8 (32 bit/64 bit)	
CPU	Windows XP	Pentium III 500 MHz or higher
	Windows Vista	Pentium III 800 MHz or higher
	Windows 7	Pentium III 1 GHz or higher
	Windows 8	
Display	1024x768 pixels or more (1920x1080 pixels or more recommended)	
RAM	Windows XP	512 MB or more
	Windows Vista	
	Windows 7	1 GB or more (32 bit)
	Windows 8	2 GB or more (64 bit)
Free hard disk space	450 MB or more for installing software	

- Refer to the Operating Instructions of “PHOTOfunSTUDIO” (PDF) for further information about the operating environment.

2 Insert the CD-ROM with the supplied software

- When you insert the supplied CD-ROM, the install menu will start.

3 Click on the [Applications] on the install menu

4 Click on the [Recommended Installation]

- Proceed with installation according to messages appearing on the screen.

- The software compatible with your PC will be installed.
- PHOTOfunSTUDIO is not compatible with Mac.
- For details on how to use “PHOTOfunSTUDIO”, see the “PHOTOfunSTUDIO” manual (PDF).

Copying still pictures and motion pictures

Getting Ready:

- When importing pictures from the built-in memory, remove any memory cards.
- Turn on the camera and computer.

1 Connect camera to computer

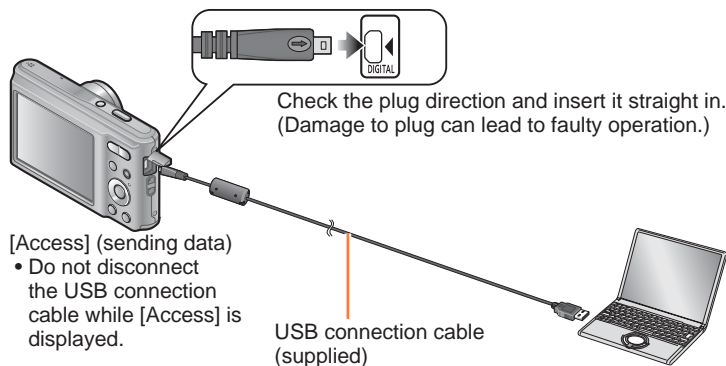

2 Use cursor button on the camera to select [PC], and press [MENU/SET]

3 Operate with your computer

- You can save pictures to use on your computer by dragging and dropping folders and files into separate folders on your computer.

- Do not use any other USB connection cables except the supplied one or a genuine Panasonic USB connection cable (optional). Using cables other than them may cause a malfunction.
- Turn off the camera before inserting or removing memory cards.
- When the battery begins to run out during communication, a warning beep sounds. Cancel communication via your computer immediately.
- For more details, consult your computer operating manual.

■ Folder and file names on computer

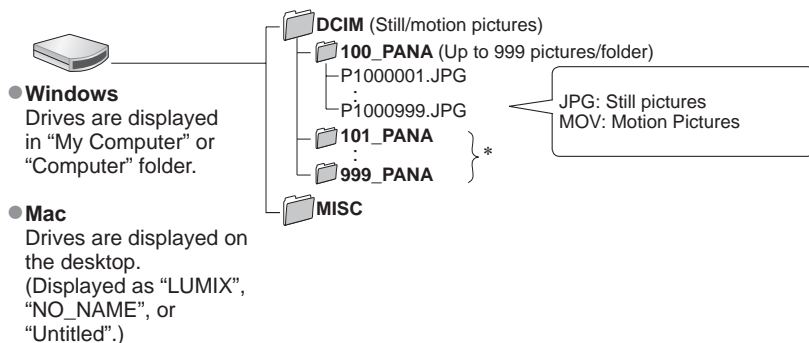

* New folders are created in the following cases:

- When pictures are taken to folders containing files numbered 999.
- When using cards already containing the same folder number (for example, pictures taken with other cameras, etc.).

■ To cancel connection

- Windows: Execute "Safely Remove Hardware" on the taskbar
- Mac: Open the Finder and click the eject icon that appears on the sidebar

■ When using Windows XP, Windows Vista, Windows 7, Windows 8, or Mac OS X

The camera can be connected to your computer even if you select [PictBridge(PTP)] in the step **2** on the previous page.

- Only picture output can be performed.
- It may not be possible to import if there are 1000 or more pictures on the card.

Printing

You can connect directly to a PictBridge-compatible printer for printing.

- Some printers can print directly from the camera's memory card.
For details, see the manual for your printer.

Getting Ready:

- When printing pictures from the built-in memory, remove any memory cards.
- Adjust the print quality or other settings on your printer, as needed.
- Turn on the camera and printer.

1 Connect camera to printer

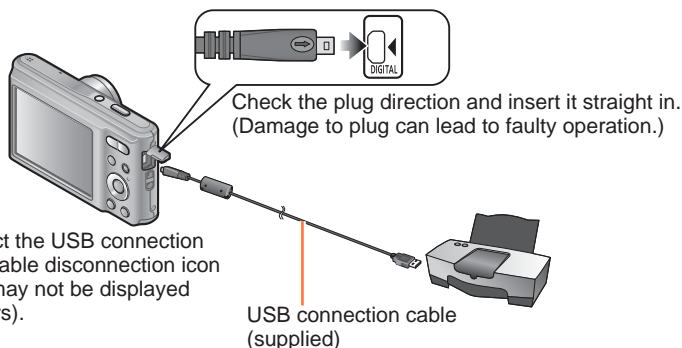

2 Use cursor button on the camera to select [PictBridge(PTP)], and press [MENU/SET]

3 Use cursor button to select a picture to print and press [MENU/SET]

4 Use cursor button to select [Print start] and press [MENU/SET]
(Print settings (→78))

■ **To cancel print** Press [MENU/SET].

(Continued on the next page)

- Do not use any other USB connection cables except the supplied one or a genuine Panasonic USB connection cable (optional). Using cables other than them may cause a malfunction.
- Disconnect USB connection cable after printing.
- Turn off the camera before inserting or removing memory cards.
- When the battery begins to run out during communication, a warning beep sounds. Cancel printing and disconnect USB connection cable.
- Motion pictures cannot be printed.

Printing multiple pictures

1 Connect camera to printer (→76)

2 Use cursor button on the camera to select [**PictBridge(PTP)**], and press [**MENU/SET**]

3 Press **▲**

4 Use cursor button to select item and press [**MENU/SET**]

- [**Multi Select**]:
 - ① Scroll between pictures with cursor button, select pictures to print with [**MENU/SET**]. (Press [**MENU/SET**] again to release selection.)
 - ② Use cursor button to select [**OK**] and press [**MENU/SET**].
- [**Select All**]: Print all pictures.

5 Use cursor button to select [**Print start**] and press [**MENU/SET**]

(Print settings (→78))







- Select [**Yes**] if print confirmation screen is displayed.

- An orange “●” displayed during printing indicates an error message.
- Print may be divided into several pictures if printing a large amount of pictures. (Remaining sheets display may differ from the number of pictures set for printing.)



Making print settings on the camera

Setting options include the number of printed pictures and their size. Make settings before selecting [Print start].

1 Use cursor button to select the item and press [MENU/SET]

Item	Settings
[Print with Date]	[ON] / [OFF]
[Num.of prints]	Set number of pictures (up to 999 pictures)
[Paper Size]	When  is selected, the printer settings take priority.
[Page Layout]	 (printer takes priority) /  (1 picture, no border) /  (1 picture, with border) /  (2 pictures) /  (4 pictures)

2 Use cursor button to select setting and press [MENU/SET]

- Items may not be displayed if incompatible with printer.
- To arrange  "2 pictures" or  "4 pictures" in the same still picture, set the number of prints for the still picture to 2 or 4.
- To print to paper sizes/layouts not supported by this camera, set to  and make settings on the printer. (Consult your printer's operating manual.)
- When setting [Print with Date] to [ON], check the date printing settings on the printer (printer settings may be prioritized).

Printing with date and text

■ Printing in store

Only recording date can be printed. Request date printing in store.

- When printing still pictures of 16:9 Aspect Ratio, check in advance that the store can accept this size.

■ Using computer

Print settings for recording date and text information can be made using "PHOTOfunSTUDIO" on the supplied CD-ROM.

■ Using printer

Recording date can be printed by setting [Print with Date] (→78) to [ON] when connecting to a printer compatible with date printing.

List of LCD monitor displays

Screens shown here are only examples. The actual display may vary.

- Press ▼ to change display.

■ In recording

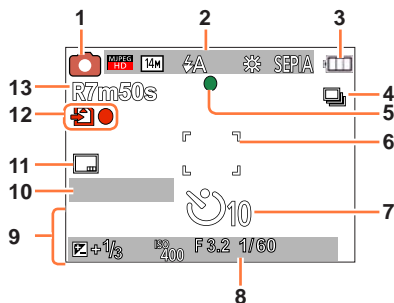

- 1 Recording Mode (→21)
- 2 Recording quality (→63)
Picture Size (→56)
Flash (→45)
Jitter alert (→27)
White Balance (→58)
Color Mode (→61)
- 3 Battery capacity (→15)
- 4 Burst Mode (→60)
- 5 Focus (→24, 28)
- 6 AF area (→28)
- 7 Self-timer Mode (→47)

- 8 Focus range
Zoom (→43)

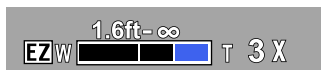

- ISO Sensitivity (→57)
Aperture value/Shutter speed (→27)
- 9 Current date/time
Exposure Compensation (→48)
Age in years/months (→55)
- 10 Elapsed recording time (→29)
XXhXXmXXs*
- 11 Date Stamp (→62)
- 12 Save destination (→17)
Recording state
- 13 Number of recordable pictures (→18)
Available recording time (→18, 29)
RXXhXXmXXs*

* [h], [m] and [s] indicate "hour", "minute" and "second".

Screens shown here are only examples. The actual display may vary.

- Press ▼ to change display.

■ In playback

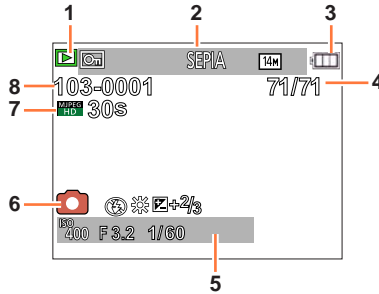

- | | |
|---------------------------------------|--|
| 1 Playback Mode (→64) | 5 Recording date/time |
| 2 Protected picture (→69) | Age in years/months (→55) |
| Date stamped display (→62) | ISO Sensitivity (→57) |
| Color Mode (→61) | Aperture value/Shutter speed (→27) |
| Picture Size (→56) | 6 Recording Mode (→21) |
| 3 Battery capacity (→15) | Flash (→45) |
| 4 Picture number/Total pictures (→31) | White Balance (→58) |
| Elapsed playback time (→34) | Exposure Compensation (→48) |
| XXhXXmXXs* | 7 Recording quality (→63) |
| | Motion picture recording time (→34) |
| | XXhXXmXXs* |
| | 8 Folder/File number (→31, 75) |
| | Save destination (→17) |
| | Cable disconnection warning icon (→76) |

* [h], [m] and [s] indicate "hour", "minute" and "second".

Message displays

Meanings of and required responses to major messages displayed on LCD monitor.

[This memory card cannot be used]

- Not compatible with the camera.
→ Use a compatible card.

[Some pictures cannot be deleted] [This picture cannot be deleted]

- Non-DCF pictures (→31) cannot be deleted.
→ Save needed data on a computer or other device, and then use [Format] on the camera. (→41)

[No additional selections can be made]

- The number of pictures that can be deleted at once has been exceeded.
- The number of pictures allowing [Resize] (multiple settings) at once has been exceeded.

[Please turn camera off and then on again] [System Error]

- The lens is not working correctly.
→ Turn on the camera again.
(Consult the dealer or your nearest Service Center if display still remains.)

[Some pictures cannot be copied] [Copy could not be completed]

- Pictures cannot be copied in following cases.
→ Picture of same name already exists in built-in memory when copying from card.
→ File is not of DCF standard. (→31)
→ Picture taken or edited on a different device.

[Not enough space on built-in memory] [Not enough memory on the card]

- There is no space left on the built-in memory or the card. When you copy pictures from the built-in memory to the card (batch copy), the pictures are copied until the capacity of the card becomes full.

[Built-In Memory Error] [Format built-in memory?]

- Displayed when formatting built-in memory via computer, etc.
→ Reformat directly using camera. Data will be deleted.

[Memory card error. This card cannot be used in this camera. Format this card?]

- The card format cannot be used with this camera.
→ Save needed data on a computer or other device, and then use [Format] on the camera. (→41)

[Insert SD card again] [Try another card]

- Access to card has failed.
→ Turn off the camera and remove the card. Reinsert the card and turn the camera on again.
- Try with a different card.

[Memory card parameter error]

- Card is not of SD standard.
- When cards in capacities of 4 GB or more are used, only SDHC or SDXC Memory Cards are supported.

[Read Error] / [Write Error] [Please check the card]

- Data read has failed.
→ Check whether card has been inserted correctly. (→16)
- Data write has failed.
→ Turn off the camera and remove the card. Reinsert the card and turn the camera on again.
- Card may possibly be damaged.
- Try with a different card.

[Motion recording was cancelled due to the limitation of the writing speed of the card]

- If recording stops even when using a card of the recommended speed class (→17), the data writing speed has dropped. If this happens, we recommend backing up the data on the memory card and formatting it (→41).
- Motion picture recording may be automatically terminated with certain cards.

[A folder cannot be created]

- Folder numbers in use have reached 999.
→ Save needed data on a computer or other device, and then use [Format] on the camera. (→41)

Q&A Troubleshooting

Try checking these items (→84 - 89) first.

If the problem persists, performing [Reset] in the [Setup] menu may resolve the issue. (Note that except for some items such as [Clock Set], all settings are returned to their values at the time of purchase.)

Battery, power

The charging lamp turns off before the battery is fully charged.

- Charging is being performed in a place with extremely high or low temperature.
→ Reconnect the USB connection cable (supplied) and retry charging in a place where ambient temperature is 10 °C to 30 °C (50 °F to 86 °F) (temperature conditions also apply to the battery itself). (When the USB connection cable is reconnected after the battery is fully charged, the charging lamp will light for approximately 1 minute.)

Camera does not work even if the camera is turned on.

- Battery is not inserted correctly (→12), or needs recharging.

LCD monitor shuts off even if the camera is turned on.

Camera switches off as soon as the camera is turned on.

- Battery needs recharging.
- [Auto Power Off] is activated (→39).
→ Press the Camera [ON/OFF] button.

Recording

Cannot record pictures.

- Built-in memory/card is full.
→ Free space by deleting unwanted pictures (→35).

Recorded pictures look white.

- Lens is dirty (fingerprints, etc.).
→ Clean lens surface with a soft, dry cloth.
- Lens is foggy (→5).

Recorded pictures are too bright/too dark.

- Adjust the exposure (→48).

Some pictures are taken when I press the shutter button just once.

- Camera is set to [Burst].

Focus not aligned correctly.

- Not set to mode appropriate for distance to subject. (Focus range varies according to recording mode.)
- Subject outside of focus range.
- Caused by jitter or subject movement.

Recording (continued)

Recorded pictures are blurred.

- Shutter speed is slower in dark locations and a picture is prone to blurring.
 - Hold camera firmly with both hands, keeping arms close to body.
 - Set [Sensitivity] to [Fiso] and [Digital Zoom] to [OFF]. (→57, 60)

Recorded pictures appear coarse, or there is interference.

- ISO Sensitivity is high, or shutter speed is low.
 - (Default [Sensitivity] setting is [Fiso] – interference may appear with indoor pictures.)
 - Lower [Sensitivity] (→57).
 - Take pictures in brighter locations.
- Camera set to [High Sens.] Scene mode.
 - (Picture becomes slightly coarser in response to high sensitivity)

Brightness or coloring of recorded picture different from real life.

- When recording under fluorescent or LED lighting fixture etc., increasing the shutter speed may introduce slight changes to brightness and color. These are a result of the characteristics of the light source and do not indicate a malfunction.

Red banding may appear on the LCD monitor or part or the entire screen may have a reddish tint, when recording or pressing the shutter button halfway.

- This is a characteristic of CCD and may appear if subject contains brighter areas. Some blurring may occur around these areas, but this is not a fault. This will be recorded in panorama pictures or motion pictures but not in still pictures.
- We recommend keeping the screen away from strong light sources such as sunlight when taking pictures.



Motion picture recording stops midway.

- With some cards, access display may appear briefly after recording, and recording may end midway.
- If recording stops even when using a card of the recommended speed class (→17), the data writing speed has dropped. If this happens, we recommend backing up the data on the memory card and formatting it (→41).

Panorama picture recording stops before finishing.

- If the pan motion of the camera is too slow, the camera assumes that the operation has been aborted and stops recording.
- If the pan motion of the camera is too shaky when it is moved toward the recording direction, the camera stops recording.
 - To record panorama pictures, pan the camera in a small semi-circular motion parallel to the recording direction at a speed of approx. 4 seconds per stroke (suggested).

The beep volume is low.

- The speaker is blocked.

LCD monitor

Brightness is unstable.

- Aperture value is set while shutter button is pressed halfway. (Does not affect recorded picture.) This symptom may also occur when the brightness changes because the zoom is operated or the camera is moved. This is the automatic aperture operation of the camera and is not a malfunction.

Monitor flickers indoors.

- If the LCD monitor flickers when you record pictures under lighting such as fluorescent or LED lighting, use [Light Freq.] in the [Setup] menu to set the utility frequency of the area where you are using the camera. (→40)

Black/blue/red/green dots or interference appears. Monitor looks distorted when touched.

- This is not a fault, and will not be recorded on the actual pictures.

Flash

No flash emitted.

- Flash set to  [Forced Flash Off] (→45).
- The flash becomes unavailable in the following cases :
 - [Burst] (Other than when using [Flash Burst])
 - Scene Modes ([Scenery] [Night Scenery] [Sunset])
 - [Panorama Shot] Mode

Multiple flashes are emitted.

- Red-eye reduction is active (→45). (Flashes twice to prevent eyes appearing red.)
- [Flash Burst] is used (→61).

Playback

Cannot view pictures. There are no recorded pictures.

- Press the Playback button.
- No pictures in built-in memory or card (pictures played from card if inserted, from built-in memory if not).
- Has the file name of the picture been changed on a computer? If so, it cannot be played back on the camera.
- The [Playback Mode] has been changed.
→ Set [Playback Mode] to [Normal Play] (→64).

Folder/file number displayed as [-]. Picture is black.

- Picture edited on computer or taken with different device.
- Battery removed immediately after picture taken, or picture taken with low battery.
→ Use [Format] to delete (→41).

Playback (continued)

Incorrect date displayed in [Calendar].

- Picture edited on computer or taken on different device.
- [Clock Set] is incorrect (→19).
(Incorrect date may be displayed in [Calendar] on pictures copied to a computer and then back to the camera, if computer and camera dates differ.)

The Playback volume and beep volume are low.

- The speaker is blocked.

White round spots like soap bubbles appear on the recorded picture.

- If you take a picture with the flash in a dark place or indoors, white round spots may appear on the picture caused by the flash reflecting particles of dust in the air. This is not a fault. A characteristic of this is that the number of round spots and their position differ in every picture.



[Thumbnail is displayed] is shown on the screen.

- The pictures may have been recorded on another device. If so, they may be displayed with poor picture quality.

Red areas in pictures appear blackened.

- When digital red-eye correction (⚡️👁️, 📷👁️) is operating, if a subject is recorded that has skin-colored areas with red areas inside, the digital red-eye correction function may blacken the red areas.
→ We recommend setting the flash to ⚡️A, 📷, or 📷, or [Red-Eye Removal] to [OFF] before recording. (→45)

The sound of the recorded motion pictures sometimes breaks up.

- This unit automatically adjusts the aperture during motion picture recording. At such times, the sound may break up. This is not a malfunction.

Motion pictures recorded on this camera cannot be played on other devices.

- Motion pictures (Motion JPEG) recorded with this camera may not be played on digital cameras of other manufacturers. Additionally, motion pictures recorded with this camera cannot be played on Panasonic LUMIX digital cameras sold before July 2008. (However, motion pictures recorded with LUMIX digital cameras sold before this date can be played on this camera.)

Computer, printer

Cannot communicate with the computer.

- Not connected correctly (→74).
- Check whether computer has recognized camera.
- Select [PC] when connecting the camera to your computer (→74).
- Turn the camera off and then on again.

Computer does not recognize card (only reads built-in memory).

- Disconnect USB connection cable (supplied) and reconnect with card in place.

Computer does not recognize card. (When using an SDXC Memory Cards)

- Check whether your computer is compatible with SDXC Memory Cards.
<http://panasonic.net/avc/sdcard/information/SDXC.html>
- A message prompting you to format the card may appear when you connect it. Do not format the card.
- If the [Access] indicator on the LCD monitor does not go off, turn off the camera before disconnecting the USB connection cable.

Cannot print when connecting to printer.

- Printer not compatible with PictBridge.
- Select [PictBridge(PTP)] when connecting the camera to your printer (→76).

Cannot print the date.

- Make date printing settings before printing.
 - With the "PHOTOfunSTUDIO" software on the CD-ROM (supplied): Select "with dates" within print settings.
- Use [Date Stamp] function when taking a picture (→62).

The edges of pictures are cut off when printing.

- Release any trimming or edgeless printing settings on printer before printing.
(Consult printer operating manual.)
- The pictures were recorded in 16:9 aspect ratio.
 - If printing in shop, check if 16:9 sizes can be printed.

Cannot print panorama pictures properly.

- The aspect ratio of panorama pictures is different from that of regular still pictures, and some panorama pictures may not be printed correctly.
 - Use a printer with support for panorama pictures. (Refer to the instruction manual for the printer.)
 - We recommend adjusting the size of a picture in accordance with print paper using the "PHOTOfunSTUDIO" software on the CD-ROM (supplied).

Others**Menu not displayed in desired language.**

- Change [Language] setting (→41).

Camera rattles if shaken.

- This sound is made by the lens movement and is not a fault.

Camera is hot.

- Camera may become a little warm during use, but this does not affect performance or quality.

Lens makes a clicking noise.

- When brightness changes, the lens may make a clicking noise and the monitor brightness may also change, but this is due to aperture settings being made. (Does not affect recording.)

Clock is incorrect.

- Camera has been left for a long period.
→ Reset the clock (→20).
- A long time was taken to set the clock (clock will be behind by the same lapse of time).

When using zoom, picture becomes slightly warped and the edges of the subject become colored.

- Pictures may be slightly warped or colored around the edges, depending on the zoom ratio, but this is not a fault.

Zoom movement stops momentarily.

- The zoom movement stops momentarily during Extended Optical Zoom operation, but this is not a malfunction.

File numbers are not recorded in sequence.

- File numbers are reset when new folders are created (→75).

File numbers have jumped backwards.

- Battery was removed/inserted with the camera turned on.
(Numbers may jump backwards if folder/file numbers are not correctly recorded.)

Usage cautions and notes

When in use

- Camera may become warm if used for long periods of time, but this is not a fault.
- **Keep this unit as far away as possible from electromagnetic equipment (such as microwave ovens, TVs, video games etc.).**
 - If you use this unit on top of or near a TV, the pictures and/or sound on this unit may be disrupted by electromagnetic wave radiation.
 - Do not use this unit near cell phones because doing so may result in noise adversely affecting the pictures and/or sound.
 - Recorded data may be damaged, or pictures may be distorted, by strong magnetic fields created by speakers or large motors.
 - Electromagnetic wave radiation generated by microprocessors may adversely affect this unit, disturbing the pictures and/or sound.
 - If this unit is adversely affected by electromagnetic equipment and stops functioning properly, turn this unit off and remove the battery or disconnect AC adaptor (supplied). Then reinsert the battery or reconnect AC adaptor and turn this unit on.

Do not use this unit near radio transmitters or high-voltage lines.

- If you record near radio transmitters or high-voltage lines, the recorded pictures and/or sound may be adversely affected.
- Do not extend the supplied cord or cable.
- Do not allow camera to come into contact with pesticides or volatile substances (can cause surface damage or coating to peel).
- Never leave the camera and the battery in a car or on a car hood in the summer. It may cause leakage of the battery electrolyte, a generation of heat, and may cause a fire and the battery to burst due to the high temperature.

Caring for your camera

To clean your camera, remove the battery or disconnect the power plug from the outlet, and wipe with a soft, dry cloth.

- Use a damp cloth to remove stubborn stains, before wiping again with a dry cloth.
- Do not use benzine, thinners, alcohol, or kitchen detergent, as these may damage the outer casing and finish of the camera.
- If using a chemically-treated cloth, read the supplied instructions carefully.

When not using for a while

- Turn off the camera before removing battery and card (ensure that battery is removed to prevent damage through over-discharge).
- Do not leave in contact with rubber or plastic bags.
- Store together with a drying agent (silica gel) if leaving in drawer, etc. Store batteries in cool (15 °C to 25 °C (59 °F to 77 °F)) places with low humidity (40%RH to 60%RH) and no major temperature changes.
- Charge battery once per year and use completely before storing again.

Memory cards

- To prevent damage to cards and data
 - Avoid high temperatures, direct sunlight, electromagnetic waves, and static electricity.
 - Do not bend, drop, or expose to strong impacts.
 - Do not touch terminals on reverse of card or allow them to become dirty or wet.
- When disposing of/transferring memory cards
 - If using the “format” or “delete” functions on your camera or computer, this only changes the file management information, and does not completely delete the data from within the memory card. When disposing of or transferring your memory cards, we recommend physically destroying them or using commercially available computer data erasing software to completely delete the data from the card. Data within memory cards should be managed responsibly.

LCD Monitor

- Do not press hard on the LCD monitor. This may cause uneven display and damage the monitor.
- In cold climates or other situations when the camera becomes cold, the LCD monitor may appear slightly darker than normal immediately after the camera is turned on. Normal brightness will return once the internal components have warmed up.

Extremely high precision technology is employed to produce the LCD monitor screen. However there may be some dark or bright spots (red, blue or green) on the screen. This is not a malfunction. The LCD monitor screen has more than 99.99% effective pixels with a mere 0.01% of the pixels inactive or always lit. The spots will not be recorded on pictures on the built-in memory or a card.

About charging the battery

- The time required for charging varies depending on conditions of battery usage. Charging takes longer at high or low temperatures and when the battery has not been used in some time.
- Battery will be warm during charging and for some time thereafter.
- Battery will run out if not used for long periods of time, even after being charged.
- Do not leave any metal items (such as clips) near the contact areas of the power plug. Otherwise, a fire and/or electric shocks may be caused by short-circuiting or the resulting heat generated.
- Frequently charging up battery is not recommended. (Frequently charging battery reduces maximum usage time and can cause battery to expand.)
- If available battery power is significantly reduced, battery is reaching end of lifespan. Please purchase a new battery.
- When charging:
 - Wipe dirt from the battery terminal with a dry cloth.
 - Keep at least 1 m (3.3 feet) away from AM radio (may cause radio interference).
- Do not use a damaged or dented battery (especially connectors), e.g. by dropping (can cause faults).
- Do not peel off or scratch the covering on the battery. Using a battery with a part of or all of its covering removed or broken may cause malfunction.

About AC adaptor (supplied)

- Keep at least 1 m (3.3 feet) away from AM radio (may cause radio interference).
- The AC adaptor (supplied) may generate whirring sounds when it is being used. This is not a malfunction.
- After use, be sure to disconnect the power supply device from the electrical outlet. (A very small amount of current is consumed if it is left connected.)

Lens

- If lens is dirty:
Images may appear slightly white if lens is dirty (fingerprints, etc.). Lightly wipe the surface of the lens with a soft, dry cloth before and after taking pictures.
- Do not leave the lens exposed to direct sunlight.
- Do not press the lens with excessive force.

When using a tripod or unipod

- Do not apply excessive force or tighten screws when they are crooked. (This may damage the camera, screw hole, or label.)
- Ensure that the tripod is stable. (Refer to the tripod instructions.)
- You may not be able to remove the card or the battery when using a tripod or unipod.

Personal Information

If birthdays are set in [Baby] Mode, keep in mind that the camera and recorded pictures will contain personal information.

Disclaimer

- Data containing personal information can be altered or lost due to malfunction, static electricity, accidents, breakdowns, repairs, or other operations.
- Panasonic will not be liable for any damage that occurs, direct or indirect, as a result of the alteration or loss of data containing personal information.

When ordering repairs or transferring/disposing of the camera

- To protect your personal information, please reset the settings (→40).
- If any pictures are contained in the built-in memory, copy (→70) them to a memory card if necessary, and then format (→41) the built-in memory.
- Remove the memory card from the camera.
- When ordering repairs, the built-in memory and other settings may be returned to the initial purchase state.
- If the above operations cannot be performed because of a camera malfunction, consult with the dealer or nearest Service Center.

When transferring or disposing of your memory card, see “When disposing of/transferring memory cards” in the previous section (→91).

When uploading pictures to online services

- Pictures may contain information that can be used for identifying individuals, such as titles, recording dates, and location information. When uploading pictures to online services, check carefully before uploading.



- SDXC Logo is a trademark of SD-3C, LLC.
- QuickTime and the QuickTime logo are trademarks or registered trademarks of Apple Inc., used under license therefrom.
- Windows and Windows Vista are either registered trademarks or trademarks of Microsoft Corporation in the United States and/or other countries.
- Mac and Mac OS are trademarks of Apple Inc., registered in the U.S. and other countries.
- Other names, company names, and product names mentioned in these instructions are trademarks or registered trademarks of the companies concerned.